

Gasketed Plate Heat Exchangers

Installation & Maintenance Manual



Fluid Dynamics Pty. Ltd.

25-27 Star Crescent, Hallam, Melbourne VIC 3803

Nat'l: 1300 58 58 59 Int'l +61 3 8786 4900

E: sales@fluidynamics.com.au

W: www.fluidynamics.com.au

CONTENTS

INTRODUCTION	3
STORAGE	4
UNPACKING	4
TRANSPORT	4
LIFTING	5
FOUNDATIONS	6
DRIP TRAY	7
CONNECTION	7
PLACEMENT	7
CONNECTING PIPES	8
SHUT-OFF VALVES	8
PRESSURE PLATE CONNECTIONS	8
COMPONENTS & THEIR FUNCTIONS	9
PLATE IDENTIFICATION	10
PLATE ORIENTATION	10
GASKETS	11
HOW IT ALL WORKS	12
FOULING	13
PRESSURE DROP	13
OPERATION	14
SHOCK PREVENTION	15
SHUT-DOWN	16
WATER HAMMER	17
PREPARATION FOR OPENING	17
REMOVING BOLTS	19
INSTALLING BOLTS	19
CLOSING HEAT EXCHANGER	20
REMOVING PLATES	21
INSERTING PLATES	21
CLEANING PLATES	22
REGASKETING	23
TROUBLE SHOOTING	24

INTRODUCTION

This Fluid Dynamics Installation & Maintenance Manual is designed to enable you to understand how to install Gasketed Plate Heat Exchangers and keep them operating properly or at least understand when you may need assistance to have them serviced.

The Gasketed Plate Heat Exchanger is a specialized design well suited to transferring heat between fluids under medium and low pressures. Welded, semi-welded and brazed heat exchangers are used for heat exchange between high pressure fluids or where a more compact product is required.

Gasketed Plate Heat Exchangers use a system of two alternating chambers, usually thin in depth, separated at their largest surface by a corrugated metal plate. The plates are formed by one piece pressing. Due to its ability to withstand high temperatures, its strength, and its corrosion resistance, stainless steel is commonly used for the plates but other metals, including titanium, are readily available.

The plates are separated by rubber sealing gaskets which are glued or clipped into a section around the edge of the plates. The plates are pressed to form troughs at right angles to the direction of flow of the liquid which runs through the channels in the heat exchanger. These troughs are arranged so that they interlink with the other plates in the heat exchanger and form channels with gaps of 1.3–1.5 mm between the plates. The plates are compressed together in a rigid frame and form an arrangement of parallel flow channels with alternating hot and cold fluids flowing in opposite directions.

The plates produce an extremely large surface area allowing for fast heat transfer. The thin chambers ensure the majority of the liquid contacts the plate to assist heat exchange. The troughs also create a turbulent flow in the liquid to maximize heat transfer. High turbulence can be obtained at low flow rates allowing high heat transfer coefficients to be achieved.

An effective maintenance system is vital for the optimum operation of Gasketed Plate Heat Exchangers. They are designed to be taken apart, cleaned and re-gasketed and the plates replaced if any are damaged or perforated.

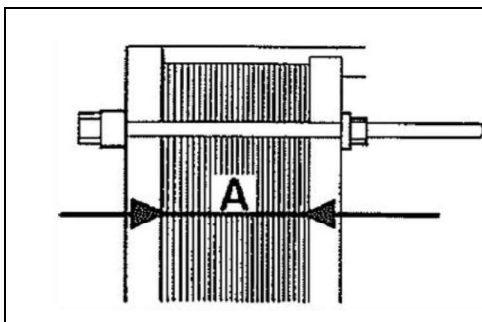

- Unless otherwise requested, FLUID DYNAMICS delivers its plate heat exchangers with the plate package tightened to its correct measurement 'A' ready for service.

STORAGE

If the unit is to be stored for periods longer than 1 month certain precautions should be taken in order to prevent unnecessary wear or damage to the equipment:

- Advise your supplier that you intend to store the unit for an extended period of time and request it be packed appropriately;
- Preferably, store the heat exchanger in a closed space with a constant temperature between 15°C to 20°C and humidity of around 70%;
- As Ozone destroys many rubber materials there should be **ABSOLUTELY NO OZONE PRODUCING** equipment (electric motors or arc-welding equipment etc.) in the room;
- Do not store organic solvents or acids in the room;
- Avoid heat radiation or ultraviolet radiation;
- Preferably leave the heat exchanger in its packing until it is time for installation;
- Wrap the plate pack with a dark non-transparent plastic film;
- Cover the tightening bolts with a good rust preventing coating; and
- If the unit is not connected to the pipe system, cover the connections.

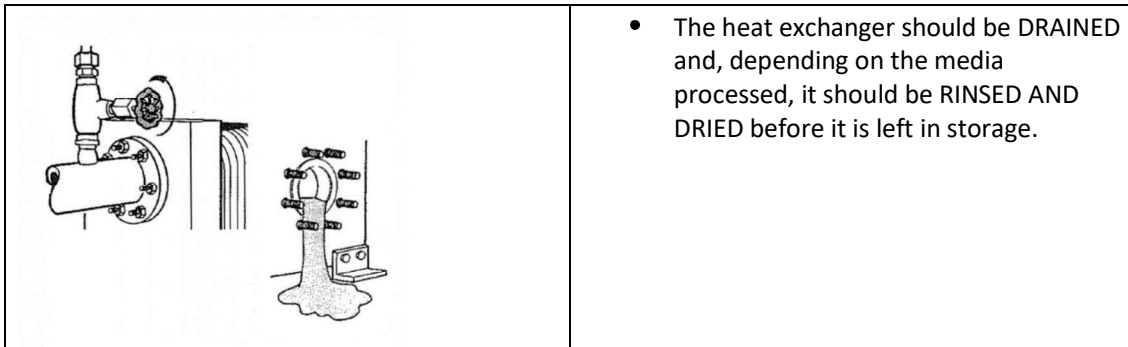

UNPACKING

- If a packing list is attached to the goods, check all parts against the packing list;
- handle the heat exchanger with care.

TRANSPORT

For safe transport remove all instruments, valves etc..

LIFTING

When lifting the unopened packing case (or skid) observe the markings indicating where to place lifting hooks. The centre of gravity of the load is important and, if marked, the actual centre of gravity is located on a vertical line directly below this mark. Use straps to lift the heat exchanger. Place the straps around the tightening bolts and carrying bar as shown or in special lifting lugs or lifting eyes, if provided.

NEVER LIFT BY THE CONNECTIONS OR THE STUDS AROUND THEM!

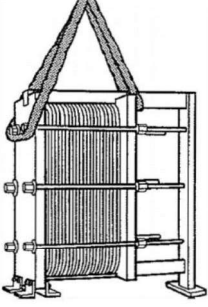
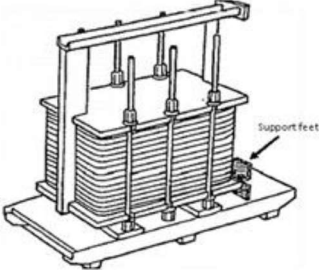
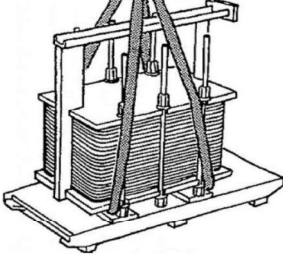
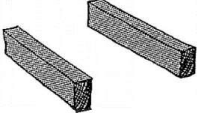
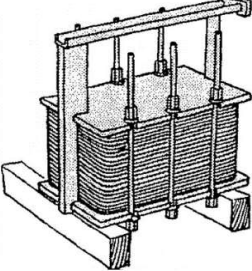
	<ul style="list-style-type: none"> • Lift with straps as shown
	<ul style="list-style-type: none"> • Remove the support feet.
	<ul style="list-style-type: none"> • Lift the heat exchanger off pallet
	<ul style="list-style-type: none"> • Place two timber beams on the floor.
	<ul style="list-style-type: none"> • Place the heat exchanger on the timber beams

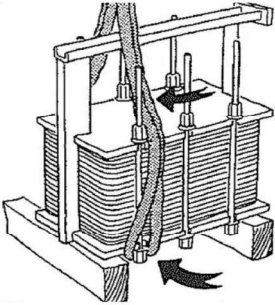
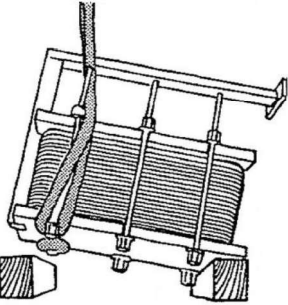
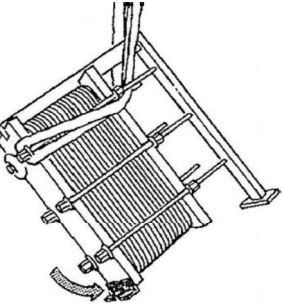
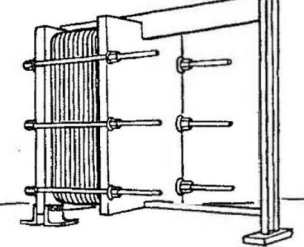
	<ul style="list-style-type: none"> Place straps around one bolt on each side
	<ul style="list-style-type: none"> Lift the heat exchanger off the timber
	<ul style="list-style-type: none"> Bolt on the support feet.
	<ul style="list-style-type: none"> Lower the heat exchanger to horizontal and secure to floor

FOUNDATIONS.

Ensure all foundations are level, solid and well drained.

DRIP TRAY

In some cases, such as installation onboard a ship or when processing corrosive liquids etc., it may be practical to place the heat exchanger in a drip tray or drainage box. Ensure the tray has sufficient capacity for the total volume of the heat exchanger and the outlet of the tray is not less than 50 mm in diameter.

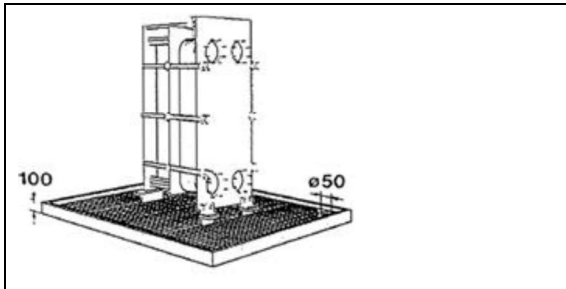
	<ul style="list-style-type: none"> • Suggested Drip Tray dimensions
---	--

CONNECTION.

Before connecting any piping to the heat exchanger ENSURE ALL FOREIGN OBJECTS HAVE BEEN RINSED OUT OF THE SYSTEM

PLACEMENT

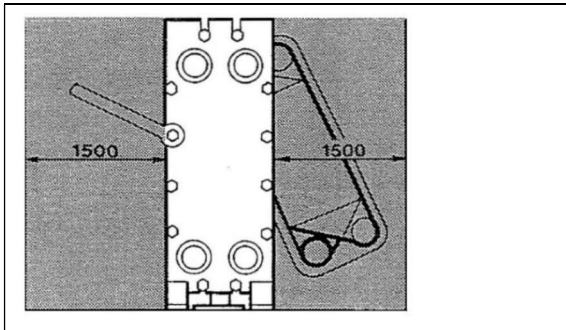
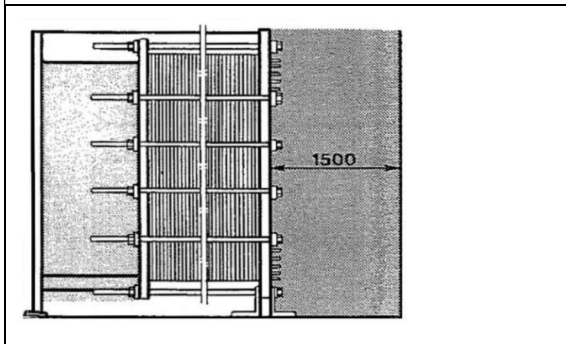
	<ul style="list-style-type: none"> • Recommended free space for opening and closing.
	<ul style="list-style-type: none"> • Allow sufficient free space around unit to allow access for future service.

The above measurements should provide reasonably good working conditions during installation of the heat exchanger and for future maintenance and service. If floor space is restricted then the dimensions may be reduced to suit available space.

CONNECTING PIPES

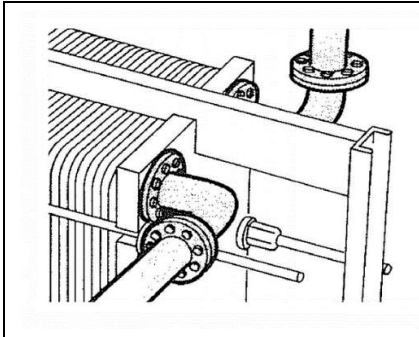

When connecting the pipe system to the heat exchanger make sure that no stress or strain is placed on the heat exchanger by the pipe system.

SHUT OFF VALVES

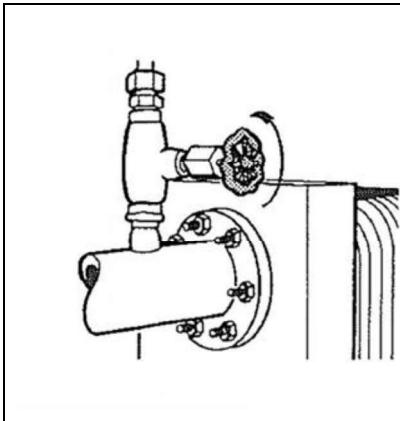

- To enable the heat exchanger to be isolated and opened when necessary, shut off valves should be provided in all connections.

PRESSURE PLATE CONNECTIONS

Some plate heat exchangers may have connections also in the pressure plate in which case it is important to check against the drawing or the data print that the plate pack has been tightened to the right measurement before any pipes are connected.

An elbow should be flanged to the connection in the pressure plate, directed upwards or sideways and with another flange located just outside the contour of the heat exchanger. This will allow the second flange, not the one attached to the pressure plate, to be disconnected when the heat exchanger is to be opened.

Venting of both sides of the heat exchanger must be provided. This is important to enable air to be drawn from the system during commissioning. It also enables air or gas to be removed during operation.

COMPONENTS & THEIR FUNCTION

In all Plate Heat Exchangers, heat is transferred from one medium to another through thin metal plates which have been pressed into a special pattern.

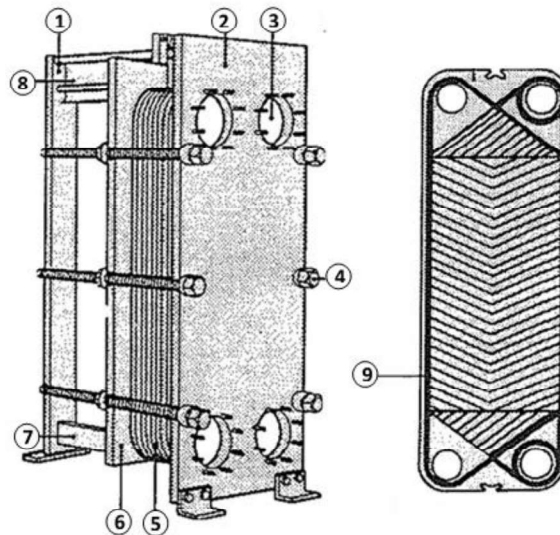

1. **Support Column** - The two bars are suspended between the Frame Plate, to which the piping is normally connected, and the Support Column.
2. **Frame Plate** – provides strength and rigidity to the unit and allows for proper tensioning of bolts and plates.
3. **Connections** - Holes matching the piping lead through the frame plate, permitting the media to enter into the heat exchanger. Threaded studs around the holes secure the pipes to the unit. Depending on the application, metallic or rubber-type linings may protect the edges of the holes against corrosion.
4. **Tightening Bolts** - With the package of thin plates hanging between the frame plate and the pressure plate, Tightening Bolts are used to press the plates together to bring them into metallic contact and to allow the gaskets to seal off the narrow passages which have now been formed between the plates.
5. **Channel Plates** – Channel Plates have a groove along the rim of the plate and around the ports to hold a Gasket which is usually made of a rubber-type material. Heat is transferred through the surface area which is contained by the gasket. The number and size of the plates in the plate pack is determined by the heat transfer duty required.
6. **Pressure Plate** - A moveable steel plate hung on the carrier bar which may, in some cases have pipes connected to it.
7. **Guiding Bar** – The Guiding Bar keeps the lower part of the plates in line.
8. **Carrying Bar** – The plates hang from the Carrying Bar
9. **Gasket** – Gaskets are usually made of a rubber-type material. Heat is transferred through the surface which is contained by the gasket, except for some small areas near the corners.

PLATE IDENTIFICATION

The plates and the gaskets play such a special role that some detailed information about them is required. Viewing the plate from the gasket side, generally a 10-digit number is imprinted in the plate or in the reinforced area of the hanger recess. This enables the plate to be identified and acts as its spare part number when ordering.

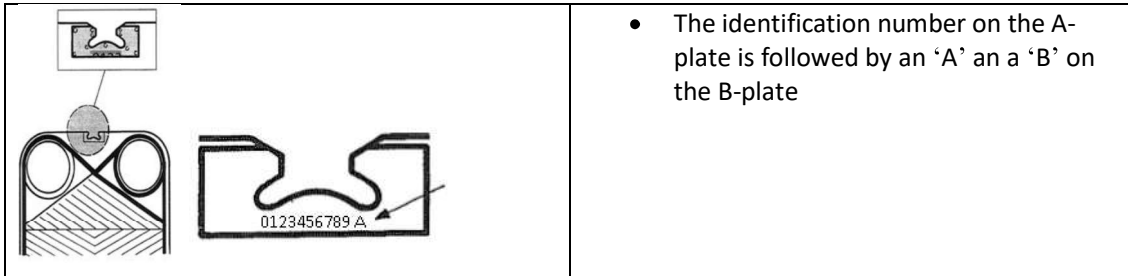
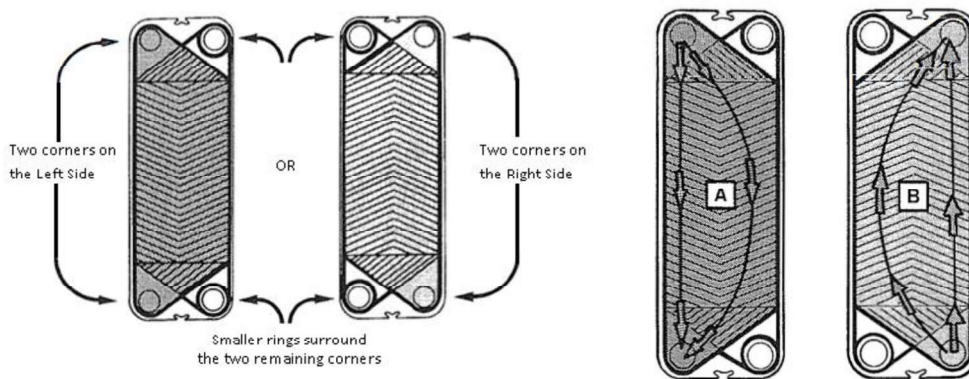

PLATE ORIENTATION



The 'A' plate is the plate with the chevrons pointing downwards.

The 'B' plate is the plate with the chevrons pointing upwards.

NOTE: the gasket rests in a groove which includes the heat transfer area shown IN grey

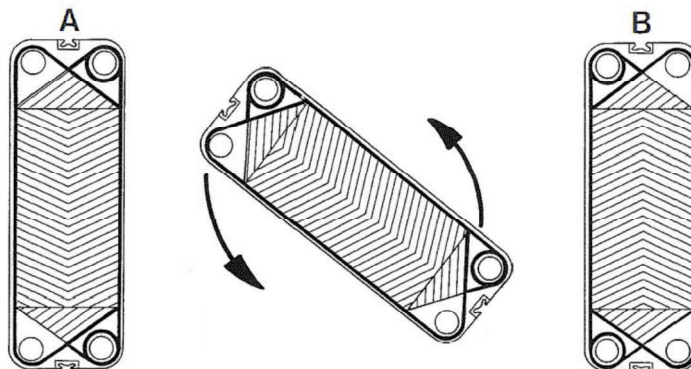

NOTE: If the plates are rotated, an upside down 'A' plate becomes a 'B' plate.

GASKETS

The Gasket is moulded in one piece and is normally made from an elastomer selected to suit the actual combination of temperature, chemical environment and possible other conditions likely to be encountered.

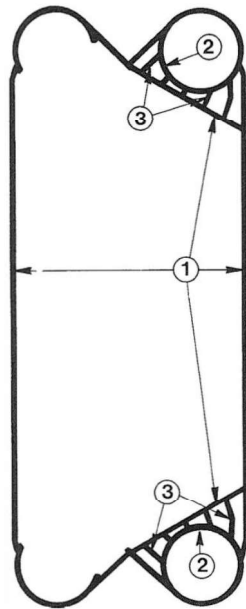

The one-piece gasket consists of:

1. one x Field Gasket
2. two x Ring Gaskets
3. various Links

The Field Gasket contains the entire heat transfer area and the two corners connected to it, while the Ring Gaskets seal off the remaining two corners.

These three pieces are held together by a few short Links which have no sealing function, their only purpose being to simply tie the Field and Ring Gaskets together and add support, Gaskets are held in place either by a suitable cement or clips.

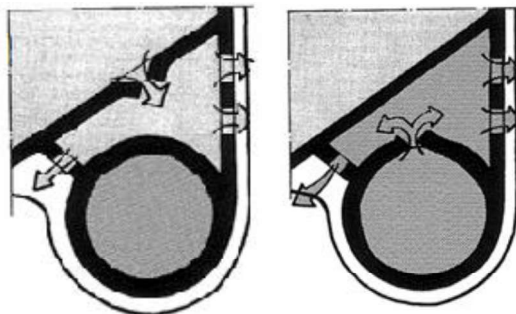

The Ring and Field Gaskets effectively keep the two media apart and prevent inter-mixing of the media in the corners where those gaskets are very close to each other.

The link pieces have slots opening the area between the Field and Ring Gaskets to atmosphere allowing any leakage across either gasket to escape.

It is important that these openings are kept clean. If they block there is a risk of local pressure build-up and may result in the media mixing.

Care should be taken not to cut or scratch the gaskets while handling plates.

HOW IT ALL WORKS

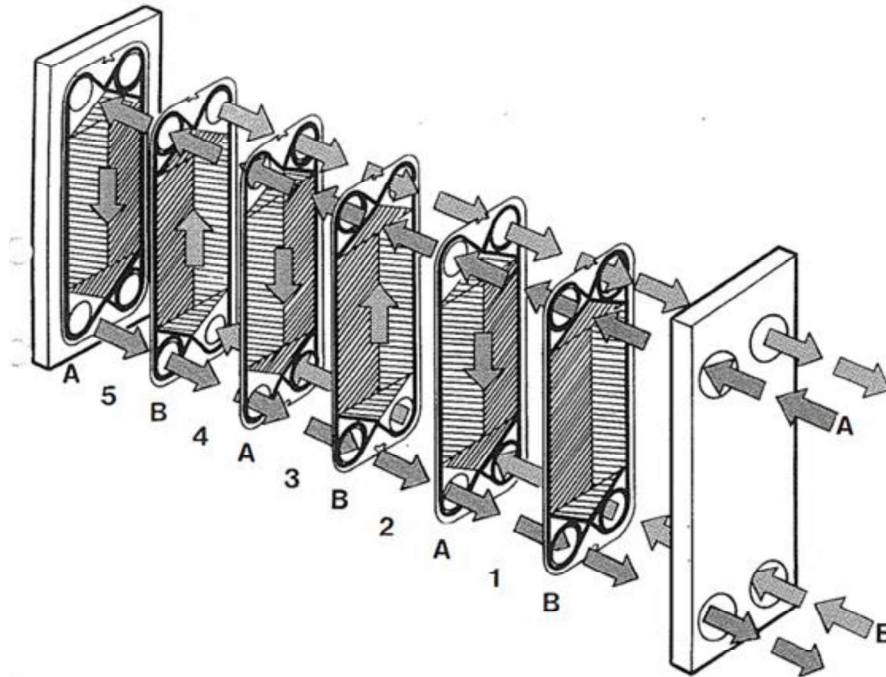

When a plate pack is pressed together the holes at the corners form continuous tunnels or manifolds, allowing the media to be distributed into the narrow passages between the plates. Due to the arrangement of the gasket on the plates and the placing of "A" and "B" plates alternately, the two liquids enter alternate passages with hot liquid running between the odd numbered passages and cold liquid between even numbered passages. The hot and cold liquids, which normally flow in opposite directions, are directed by the gaskets and are separated by the thin metal plates. During the passage through the unit, the hot liquid will exchange some of its heat energy through the plate with the colder medium on the other side. Finally, the media are led to the other end of the heat exchanger and discharged.

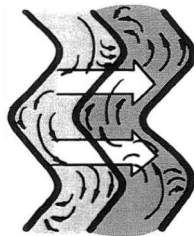

The novel pattern into which the plate material has been formed gives strength and rigidity and greatly increases the rate of heat transfer from the warmer medium to the metal wall and from the wall to the other medium.

FOULING

The high heat flow through the plates can be seriously reduced by the formation of deposits of various kinds of contamination on the surface of the walls.

The pattern of corrugation on plates induces turbulence which reduces the formation of deposits on the plate surface.

As deposits build up they increase the total wall thickness of the plates and, as they likely consist of materials that have a much lower thermal conductivity than the metal plate, the deposits can severely reduce the overall heat transfer rate and may cause corrosion to the plates.

PRESSURE DROP

Pressure drops are wasted energy.

All pipe systems, and any equipment included in those systems, offer resistance to media flowing through them.

Some pressure drop is unavoidable, but it should be kept as close as possible to the designed value.

The formation of deposits on the heat transfer surfaces instantly leads to a reduction of the free space between the plates resulting in more energy being required to get the desired flow through the heat exchanger.

Fouling of the surfaces is undesirable and should be systematically monitored and removed.

If strainers, filters or other means of protection have not been provided, larger particles and fibres may be drawn into the heat exchanger and clog it or at least reduce its performance.



A reduced ability by the heat exchanger to hold the desired temperatures, in combination with an increased pressure drop on any of the media, indicates that fouling or clogging is taking place.

OPERATION

It is very important that the system to which the heat exchanger is connected, is protected against sudden and extreme variations of temperature and pressure.

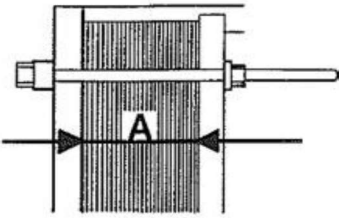
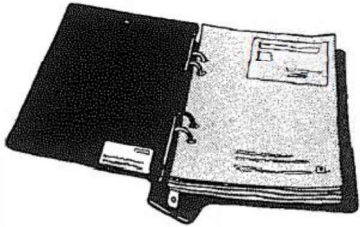
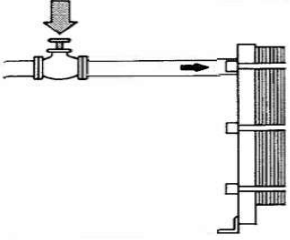
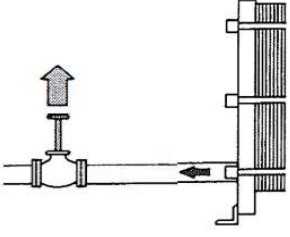
This is not only for the heat exchanger but also for the pipe system itself and every piece of equipment included in it.

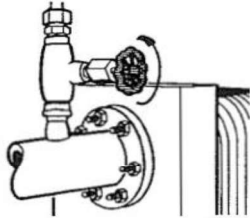
	<ul style="list-style-type: none"> • BEFORE STARTING UP FOR THE FIRST TIME OR AFTER A LONG TIME OF CLOSE-DOWN, MAKE SURE THAT THE PLATE RACK IS COMPRESSED TO THE CORRECT MEASUREMENT 'A'! • Check with the Data-Print which is located in the inside pocket of the back cover.
	<ul style="list-style-type: none"> • Before starting any pump, first check whether instructions exist as to the order in which the pumps should be started.
	<ul style="list-style-type: none"> • Ensure the valve between the pump and the unit controlling the flowrate of the system which you are about to start up is closed.
	<ul style="list-style-type: none"> • If there is a valve at the exit, ensure that it is fully open.

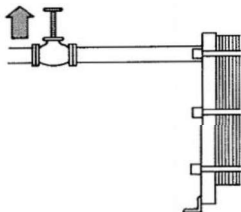
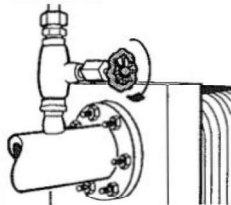
	<ul style="list-style-type: none"> • Open the vent
	<ul style="list-style-type: none"> • Start the pump
	<ul style="list-style-type: none"> • Open the valve slowly
	<ul style="list-style-type: none"> • When all the air is out, close the vent. • Repeat the procedure for the other media.

WARNING

CHLORINE:

- is a growth inhibitor commonly used in cooling water systems;
- reduces the corrosion resistance of stainless steels including Hasteloy, Incoloy, Inconel and SMO;
- weakens the protection layer of these steels; and
- makes these steels susceptible to corrosion attacks.

NOTE: Titanium is not affected by Chlorine.

SHOCK PREVENTION.

To prevent shocks to the system, ensure that all adjustments of flowrates required to maintain correct temperatures or pressure drops are made **SLOWLY**.

Problems in maintaining the performance of the heat exchanger may be due to a change in some of the temperature conditions, the heat load or by fouling.

If the apparatus is operating satisfactorily, do not interfere with it.

SHUT-DOWN

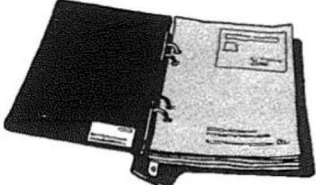
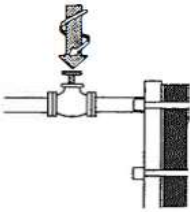
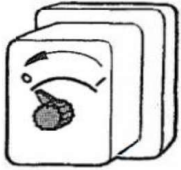
	<ul style="list-style-type: none"> • First establish whether instructions exist as to which side should be stopped first.
	<ul style="list-style-type: none"> • SLOWLY close the valve controlling the flowrate of the pump you are about to stop.
	<ul style="list-style-type: none"> • When the valve is closed, stop the pump. • Repeat the procedure for the other side.

If for any reason the heat exchanger is shut down for an extended period (more than a few days), it should be drained and, depending on the media being processed, rinse and dry the unit.

THE RISKS OF FAILING TO FOLLOW START-UP AND SHUT-DOWN PROCEDURES.

- A liquid in motion in a pipe system represents a lot of energy. Be very careful when dealing with it;
- Particularly when the fluid is stopped, it is imperative that setting it in motion is done smoothly;
- Valves must be operated gradually;
- The longer the pipes and the higher the flowrate, the more important this becomes.

NOTE! Fast-closing valves should not be used unless the pipes of the system are very short.

WATER HAMMER

Water Hammer is the name given to a short-lasting pressure peak travelling along the pipe as a wave at the speed of sound and results from a sudden deceleration of the fluid in a closed system.

Water Hammer is usually related to shutting down a system.

However, when starting up a system with open valves and empty pipes, the fluid may surge into some obstacle such as a strainer, a flow meter or a heat exchanger which causes a sudden reduction or cessation of the flow velocity creating water hammer.

In some cases, the pressure surge caused by such a sudden stop of the of the fluid's motion can be several times greater than the safe operating pressure of the system.

It is very important for the protection of the whole installation that start-ups and close-downs are carried out slowly and with great care.

PREPARATION FOR OPENING

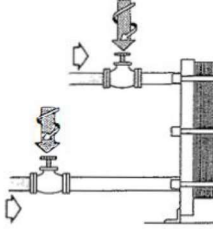
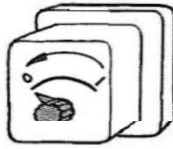
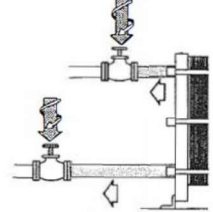
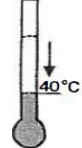
	<ul style="list-style-type: none"> • Slowly close the valves on the inlets, closing the greatest pressure first
	<ul style="list-style-type: none"> • Switch off pumps.
	<ul style="list-style-type: none"> • Slowly close the valves on both outlets
	<ul style="list-style-type: none"> • Wait until the heat exchanger has cooled down to about 40° C.

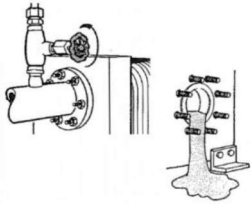
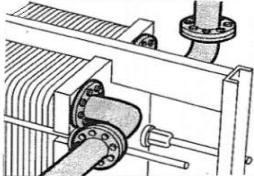
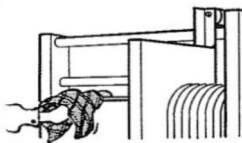
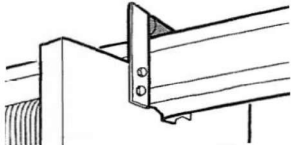
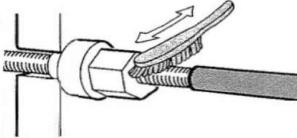
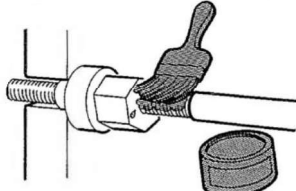
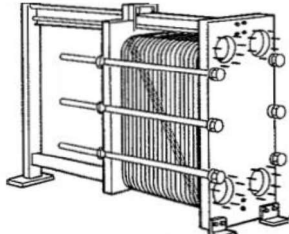
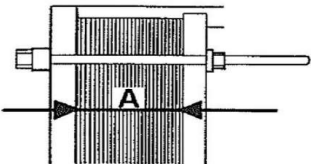
	<ul style="list-style-type: none"> • Drain the heat exchanger
	<ul style="list-style-type: none"> • Dismantle connections to the pressure plate to enable it to be moved freely along the carrying bar.
	<ul style="list-style-type: none"> • Inspect the sliding surfaces of the carrying bar and wipe clean.
	<ul style="list-style-type: none"> • Inspect the pressure plate roller
	<ul style="list-style-type: none"> • Pull back the plastic covers on the tightening bolts; brush the threads clean with a steel wire brush.
	<ul style="list-style-type: none"> • Lubricate the threads with a thin layer of grease.
	<ul style="list-style-type: none"> • Mark the plate assembly on the outside by a diagonal line, or number the plates in sequence.
	<ul style="list-style-type: none"> • Measure and record dimension 'A'

REMOVING BOLTS

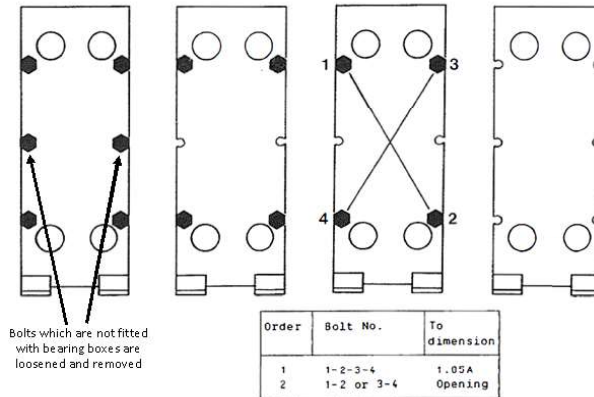

Open the bolts alternately and diagonally

NOTE: Skewing of the pressure plate during opening must not exceed 10 mm (2 turns per bolt) across the width and 25 mm (5 turns per bolt) vertically.

INSTALLING BOLTS

Place other bolts in position

- Inspect the washers.
- When fully tightened, the bolts should all be equally tensioned.
- The difference between the plate pack lengths measured at adjacent bolts should not exceed:
 - 2mm when dimension A is < 1000mm
 - 4mm when dimension A is > 1000mm
- The plate pack length at all bolts must not differ with more than 1%
- If the unit does not seal fully, tighten it to give dimension A-1%.
- Do Not exceed the maximum tightening torque

IF DIMENSION 'A' IS NOT REACHED WITH APPLICATION OF MAXIMUM TIGHTENING TORQUE:

- Check the number of plates and dimension A.
- Check that all the nuts and bearing boxes are running freely. Clean, lubricate or replace.
- Fit all the bolts and tighten alternately.

CLOSING HEAT EXCHANGER

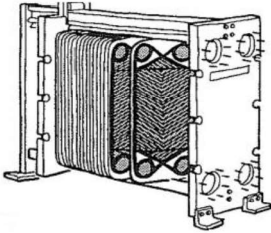
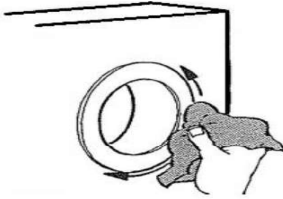
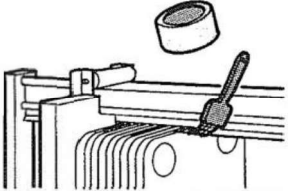
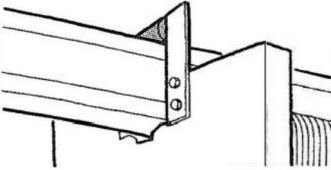
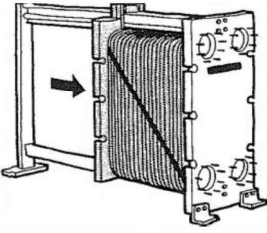
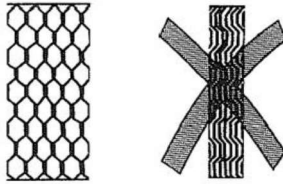
	<ul style="list-style-type: none"> • Check that all the sealing surfaces are clean.
	<ul style="list-style-type: none"> • Check that the ring gaskets are in good condition and in position.
	<ul style="list-style-type: none"> • Clean and lubricate the sliding surfaces of the carrying bar.
	<ul style="list-style-type: none"> • Inspect the pressure plate roller.
	<ul style="list-style-type: none"> • Check against the data printout and ensure the plates are hanging in the correct order. • Press the plate assembly together. Reassembled as marked or numbered
	<ul style="list-style-type: none"> • If the plates are correctly assembled the edges form a 'honeycomb' pattern.

REMOVING PLATES

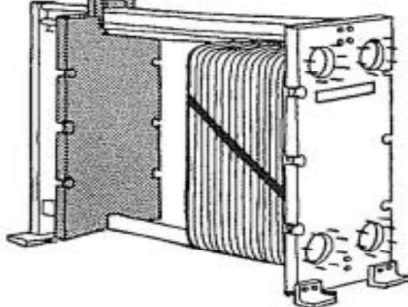
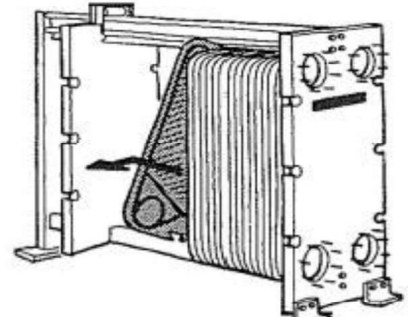
	<ul style="list-style-type: none"> • Push the pressure plate against the support column.
	<ul style="list-style-type: none"> • Remove the plates.

INSERTING PLATES

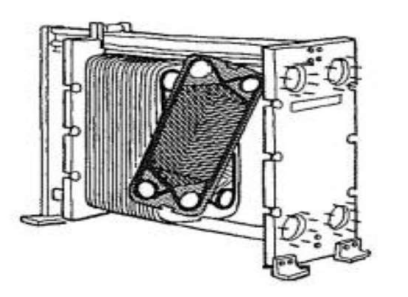
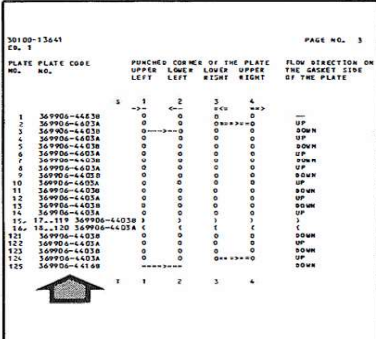
	<ul style="list-style-type: none"> • Hang the plates with their backs towards the pressure plate (the side without gasket). 																																																																																																																																																																																																																																																																																																																																																																																																																																																																																																																																																																																																																																																																																																																																							
 <p>361 00-13641 Cdr. 1</p> <p>PAGE NO. 3</p> <table border="1"> <thead> <tr> <th rowspan="2">PLATE NO.</th> <th rowspan="2">PLATE CODE</th> <th colspan="4">PUNCHED CORNER OF THE PLATE</th> <th rowspan="2">FLOW DIRECTION ON THE GASKET SIDE OF THE PLATE</th> </tr> <tr> <th>UPPER LEFT</th> <th>LOWER LEFT</th> <th>UPPER RIGHT</th> <th>LOWER RIGHT</th> </tr> </thead> <tbody> <tr><td>1</td><td>3699DS-44E30</td><td>0</td><td>0</td><td>0</td><td>0</td><td>UP</td></tr> <tr><td>2</td><td>3699DS-44D3A</td><td>0</td><td>0</td><td>0</td><td>0</td><td>DOWN</td></tr> <tr><td>3</td><td>3699DS-44E30</td><td>0</td><td>0</td><td>0</td><td>0</td><td>UP</td></tr> <tr><td>4</td><td>3699DS-44D3A</td><td>0</td><td>0</td><td>0</td><td>0</td><td>DOWN</td></tr> <tr><td>5</td><td>3699DS-44E30</td><td>0</td><td>0</td><td>0</td><td>0</td><td>UP</td></tr> <tr><td>6</td><td>3699DS-44D3A</td><td>0</td><td>0</td><td>0</td><td>0</td><td>DOWN</td></tr> <tr><td>7</td><td>3699DS-44E30</td><td>0</td><td>0</td><td>0</td><td>0</td><td>UP</td></tr> <tr><td>8</td><td>3699DS-44D3A</td><td>0</td><td>0</td><td>0</td><td>0</td><td>DOWN</td></tr> <tr><td>9</td><td>3699DS-44E30</td><td>0</td><td>0</td><td>0</td><td>0</td><td>UP</td></tr> <tr><td>10</td><td>3699DS-44D3A</td><td>0</td><td>0</td><td>0</td><td>0</td><td>DOWN</td></tr> <tr><td>11</td><td>3699DS-44E30</td><td>0</td><td>0</td><td>0</td><td>0</td><td>UP</td></tr> <tr><td>12</td><td>3699DS-44D3A</td><td>0</td><td>0</td><td>0</td><td>0</td><td>DOWN</td></tr> <tr><td>13</td><td>3699DS-44E30</td><td>0</td><td>0</td><td>0</td><td>0</td><td>UP</td></tr> <tr><td>14</td><td>3699DS-44D3A</td><td>0</td><td>0</td><td>0</td><td>0</td><td>DOWN</td></tr> <tr><td>15</td><td>3699DS-44E30</td><td>0</td><td>0</td><td>0</td><td>0</td><td>UP</td></tr> <tr><td>16</td><td>12...120 3699DS-44D3A</td><td>0</td><td>0</td><td>0</td><td>0</td><td>DOWN</td></tr> <tr><td>17</td><td>3699DS-44E30</td><td>0</td><td>0</td><td>0</td><td>0</td><td>UP</td></tr> <tr><td>18</td><td>3699DS-44D3A</td><td>0</td><td>0</td><td>0</td><td>0</td><td>DOWN</td></tr> <tr><td>19</td><td>3699DS-44E30</td><td>0</td><td>0</td><td>0</td><td>0</td><td>UP</td></tr> <tr><td>20</td><td>3699DS-44D3A</td><td>0</td><td>0</td><td>0</td><td>0</td><td>DOWN</td></tr> <tr><td>21</td><td>3699DS-44E30</td><td>0</td><td>0</td><td>0</td><td>0</td><td>UP</td></tr> <tr><td>22</td><td>3699DS-44D3A</td><td>0</td><td>0</td><td>0</td><td>0</td><td>DOWN</td></tr> <tr><td>23</td><td>3699DS-44E30</td><td>0</td><td>0</td><td>0</td><td>0</td><td>UP</td></tr> <tr><td>24</td><td>3699DS-44D3A</td><td>0</td><td>0</td><td>0</td><td>0</td><td>DOWN</td></tr> <tr><td>25</td><td>3699DS-44E30</td><td>0</td><td>0</td><td>0</td><td>0</td><td>UP</td></tr> <tr><td>26</td><td>3699DS-44D3A</td><td>0</td><td>0</td><td>0</td><td>0</td><td>DOWN</td></tr> <tr><td>27</td><td>3699DS-44E30</td><td>0</td><td>0</td><td>0</td><td>0</td><td>UP</td></tr> <tr><td>28</td><td>3699DS-44D3A</td><td>0</td><td>0</td><td>0</td><td>0</td><td>DOWN</td></tr> <tr><td>29</td><td>3699DS-44E30</td><td>0</td><td>0</td><td>0</td><td>0</td><td>UP</td></tr> <tr><td>30</td><td>3699DS-44D3A</td><td>0</td><td>0</td><td>0</td><td>0</td><td>DOWN</td></tr> <tr><td>31</td><td>3699DS-44E30</td><td>0</td><td>0</td><td>0</td><td>0</td><td>UP</td></tr> <tr><td>32</td><td>3699DS-44D3A</td><td>0</td><td>0</td><td>0</td><td>0</td><td>DOWN</td></tr> <tr><td>33</td><td>3699DS-44E30</td><td>0</td><td>0</td><td>0</td><td>0</td><td>UP</td></tr> <tr><td>34</td><td>3699DS-44D3A</td><td>0</td><td>0</td><td>0</td><td>0</td><td>DOWN</td></tr> <tr><td>35</td><td>3699DS-44E30</td><td>0</td><td>0</td><td>0</td><td>0</td><td>UP</td></tr> <tr><td>36</td><td>3699DS-44D3A</td><td>0</td><td>0</td><td>0</td><td>0</td><td>DOWN</td></tr> <tr><td>37</td><td>3699DS-44E30</td><td>0</td><td>0</td><td>0</td><td>0</td><td>UP</td></tr> <tr><td>38</td><td>3699DS-44D3A</td><td>0</td><td>0</td><td>0</td><td>0</td><td>DOWN</td></tr> <tr><td>39</td><td>3699DS-44E30</td><td>0</td><td>0</td><td>0</td><td>0</td><td>UP</td></tr> <tr><td>40</td><td>3699DS-44D3A</td><td>0</td><td>0</td><td>0</td><td>0</td><td>DOWN</td></tr> <tr><td>41</td><td>3699DS-44E30</td><td>0</td><td>0</td><td>0</td><td>0</td><td>UP</td></tr> <tr><td>42</td><td>3699DS-44D3A</td><td>0</td><td>0</td><td>0</td><td>0</td><td>DOWN</td></tr> <tr><td>43</td><td>3699DS-44E30</td><td>0</td><td>0</td><td>0</td><td>0</td><td>UP</td></tr> <tr><td>44</td><td>3699DS-44D3A</td><td>0</td><td>0</td><td>0</td><td>0</td><td>DOWN</td></tr> <tr><td>45</td><td>3699DS-44E30</td><td>0</td><td>0</td><td>0</td><td>0</td><td>UP</td></tr> <tr><td>46</td><td>3699DS-44D3A</td><td>0</td><td>0</td><td>0</td><td>0</td><td>DOWN</td></tr> <tr><td>47</td><td>3699DS-44E30</td><td>0</td><td>0</td><td>0</td><td>0</td><td>UP</td></tr> <tr><td>48</td><td>3699DS-44D3A</td><td>0</td><td>0</td><td>0</td><td>0</td><td>DOWN</td></tr> <tr><td>49</td><td>3699DS-44E30</td><td>0</td><td>0</td><td>0</td><td>0</td><td>UP</td></tr> <tr><td>50</td><td>3699DS-44D3A</td><td>0</td><td>0</td><td>0</td><td>0</td><td>DOWN</td></tr> <tr><td>51</td><td>3699DS-44E30</td><td>0</td><td>0</td><td>0</td><td>0</td><td>UP</td></tr> <tr><td>52</td><td>3699DS-44D3A</td><td>0</td><td>0</td><td>0</td><td>0</td><td>DOWN</td></tr> <tr><td>53</td><td>3699DS-44E30</td><td>0</td><td>0</td><td>0</td><td>0</td><td>UP</td></tr> <tr><td>54</td><td>3699DS-44D3A</td><td>0</td><td>0</td><td>0</td><td>0</td><td>DOWN</td></tr> <tr><td>55</td><td>3699DS-44E30</td><td>0</td><td>0</td><td>0</td><td>0</td><td>UP</td></tr> <tr><td>56</td><td>3699DS-44D3A</td><td>0</td><td>0</td><td>0</td><td>0</td><td>DOWN</td></tr> <tr><td>57</td><td>3699DS-44E30</td><td>0</td><td>0</td><td>0</td><td>0</td><td>UP</td></tr> <tr><td>58</td><td>3699DS-44D3A</td><td>0</td><td>0</td><td>0</td><td>0</td><td>DOWN</td></tr> <tr><td>59</td><td>3699DS-44E30</td><td>0</td><td>0</td><td>0</td><td>0</td><td>UP</td></tr> <tr><td>60</td><td>3699DS-44D3A</td><td>0</td><td>0</td><td>0</td><td>0</td><td>DOWN</td></tr> <tr><td>61</td><td>3699DS-44E30</td><td>0</td><td>0</td><td>0</td><td>0</td><td>UP</td></tr> <tr><td>62</td><td>3699DS-44D3A</td><td>0</td><td>0</td><td>0</td><td>0</td><td>DOWN</td></tr> <tr><td>63</td><td>3699DS-44E30</td><td>0</td><td>0</td><td>0</td><td>0</td><td>UP</td></tr> <tr><td>64</td><td>3699DS-44D3A</td><td>0</td><td>0</td><td>0</td><td>0</td><td>DOWN</td></tr> <tr><td>65</td><td>3699DS-44E30</td><td>0</td><td>0</td><td>0</td><td>0</td><td>UP</td></tr> <tr><td>66</td><td>3699DS-44D3A</td><td>0</td><td>0</td><td>0</td><td>0</td><td>DOWN</td></tr> <tr><td>67</td><td>3699DS-44E30</td><td>0</td><td>0</td><td>0</td><td>0</td><td>UP</td></tr> <tr><td>68</td><td>3699DS-44D3A</td><td>0</td><td>0</td><td>0</td><td>0</td><td>DOWN</td></tr> <tr><td>69</td><td>3699DS-44E30</td><td>0</td><td>0</td><td>0</td><td>0</td><td>UP</td></tr> <tr><td>70</td><td>3699DS-44D3A</td><td>0</td><td>0</td><td>0</td><td>0</td><td>DOWN</td></tr> <tr><td>71</td><td>3699DS-44E30</td><td>0</td><td>0</td><td>0</td><td>0</td><td>UP</td></tr> <tr><td>72</td><td>3699DS-44D3A</td><td>0</td><td>0</td><td>0</td><td>0</td><td>DOWN</td></tr> <tr><td>73</td><td>3699DS-44E30</td><td>0</td><td>0</td><td>0</td><td>0</td><td>UP</td></tr> <tr><td>74</td><td>3699DS-44D3A</td><td>0</td><td>0</td><td>0</td><td>0</td><td>DOWN</td></tr> <tr><td>75</td><td>3699DS-44E30</td><td>0</td><td>0</td><td>0</td><td>0</td><td>UP</td></tr> <tr><td>76</td><td>3699DS-44D3A</td><td>0</td><td>0</td><td>0</td><td>0</td><td>DOWN</td></tr> <tr><td>77</td><td>3699DS-44E30</td><td>0</td><td>0</td><td>0</td><td>0</td><td>UP</td></tr> <tr><td>78</td><td>3699DS-44D3A</td><td>0</td><td>0</td><td>0</td><td>0</td><td>DOWN</td></tr> <tr><td>79</td><td>3699DS-44E30</td><td>0</td><td>0</td><td>0</td><td>0</td><td>UP</td></tr> <tr><td>80</td><td>3699DS-44D3A</td><td>0</td><td>0</td><td>0</td><td>0</td><td>DOWN</td></tr> <tr><td>81</td><td>3699DS-44E30</td><td>0</td><td>0</td><td>0</td><td>0</td><td>UP</td></tr> <tr><td>82</td><td>3699DS-44D3A</td><td>0</td><td>0</td><td>0</td><td>0</td><td>DOWN</td></tr> <tr><td>83</td><td>3699DS-44E30</td><td>0</td><td>0</td><td>0</td><td>0</td><td>UP</td></tr> <tr><td>84</td><td>3699DS-44D3A</td><td>0</td><td>0</td><td>0</td><td>0</td><td>DOWN</td></tr> <tr><td>85</td><td>3699DS-44E30</td><td>0</td><td>0</td><td>0</td><td>0</td><td>UP</td></tr> <tr><td>86</td><td>3699DS-44D3A</td><td>0</td><td>0</td><td>0</td><td>0</td><td>DOWN</td></tr> <tr><td>87</td><td>3699DS-44E30</td><td>0</td><td>0</td><td>0</td><td>0</td><td>UP</td></tr> <tr><td>88</td><td>3699DS-44D3A</td><td>0</td><td>0</td><td>0</td><td>0</td><td>DOWN</td></tr> <tr><td>89</td><td>3699DS-44E30</td><td>0</td><td>0</td><td>0</td><td>0</td><td>UP</td></tr> <tr><td>90</td><td>3699DS-44D3A</td><td>0</td><td>0</td><td>0</td><td>0</td><td>DOWN</td></tr> <tr><td>91</td><td>3699DS-44E30</td><td>0</td><td>0</td><td>0</td><td>0</td><td>UP</td></tr> <tr><td>92</td><td>3699DS-44D3A</td><td>0</td><td>0</td><td>0</td><td>0</td><td>DOWN</td></tr> <tr><td>93</td><td>3699DS-44E30</td><td>0</td><td>0</td><td>0</td><td>0</td><td>UP</td></tr> <tr><td>94</td><td>3699DS-44D3A</td><td>0</td><td>0</td><td>0</td><td>0</td><td>DOWN</td></tr> <tr><td>95</td><td>3699DS-44E30</td><td>0</td><td>0</td><td>0</td><td>0</td><td>UP</td></tr> <tr><td>96</td><td>3699DS-44D3A</td><td>0</td><td>0</td><td>0</td><td>0</td><td>DOWN</td></tr> <tr><td>97</td><td>3699DS-44E30</td><td>0</td><td>0</td><td>0</td><td>0</td><td>UP</td></tr> <tr><td>98</td><td>3699DS-44D3A</td><td>0</td><td>0</td><td>0</td><td>0</td><td>DOWN</td></tr> <tr><td>99</td><td>3699DS-44E30</td><td>0</td><td>0</td><td>0</td><td>0</td><td>UP</td></tr> <tr><td>100</td><td>3699DS-44D3A</td><td>0</td><td>0</td><td>0</td><td>0</td><td>DOWN</td></tr> </tbody> </table>	PLATE NO.	PLATE CODE	PUNCHED CORNER OF THE PLATE				FLOW DIRECTION ON THE GASKET SIDE OF THE PLATE	UPPER LEFT	LOWER LEFT	UPPER RIGHT	LOWER RIGHT	1	3699DS-44E30	0	0	0	0	UP	2	3699DS-44D3A	0	0	0	0	DOWN	3	3699DS-44E30	0	0	0	0	UP	4	3699DS-44D3A	0	0	0	0	DOWN	5	3699DS-44E30	0	0	0	0	UP	6	3699DS-44D3A	0	0	0	0	DOWN	7	3699DS-44E30	0	0	0	0	UP	8	3699DS-44D3A	0	0	0	0	DOWN	9	3699DS-44E30	0	0	0	0	UP	10	3699DS-44D3A	0	0	0	0	DOWN	11	3699DS-44E30	0	0	0	0	UP	12	3699DS-44D3A	0	0	0	0	DOWN	13	3699DS-44E30	0	0	0	0	UP	14	3699DS-44D3A	0	0	0	0	DOWN	15	3699DS-44E30	0	0	0	0	UP	16	12...120 3699DS-44D3A	0	0	0	0	DOWN	17	3699DS-44E30	0	0	0	0	UP	18	3699DS-44D3A	0	0	0	0	DOWN	19	3699DS-44E30	0	0	0	0	UP	20	3699DS-44D3A	0	0	0	0	DOWN	21	3699DS-44E30	0	0	0	0	UP	22	3699DS-44D3A	0	0	0	0	DOWN	23	3699DS-44E30	0	0	0	0	UP	24	3699DS-44D3A	0	0	0	0	DOWN	25	3699DS-44E30	0	0	0	0	UP	26	3699DS-44D3A	0	0	0	0	DOWN	27	3699DS-44E30	0	0	0	0	UP	28	3699DS-44D3A	0	0	0	0	DOWN	29	3699DS-44E30	0	0	0	0	UP	30	3699DS-44D3A	0	0	0	0	DOWN	31	3699DS-44E30	0	0	0	0	UP	32	3699DS-44D3A	0	0	0	0	DOWN	33	3699DS-44E30	0	0	0	0	UP	34	3699DS-44D3A	0	0	0	0	DOWN	35	3699DS-44E30	0	0	0	0	UP	36	3699DS-44D3A	0	0	0	0	DOWN	37	3699DS-44E30	0	0	0	0	UP	38	3699DS-44D3A	0	0	0	0	DOWN	39	3699DS-44E30	0	0	0	0	UP	40	3699DS-44D3A	0	0	0	0	DOWN	41	3699DS-44E30	0	0	0	0	UP	42	3699DS-44D3A	0	0	0	0	DOWN	43	3699DS-44E30	0	0	0	0	UP	44	3699DS-44D3A	0	0	0	0	DOWN	45	3699DS-44E30	0	0	0	0	UP	46	3699DS-44D3A	0	0	0	0	DOWN	47	3699DS-44E30	0	0	0	0	UP	48	3699DS-44D3A	0	0	0	0	DOWN	49	3699DS-44E30	0	0	0	0	UP	50	3699DS-44D3A	0	0	0	0	DOWN	51	3699DS-44E30	0	0	0	0	UP	52	3699DS-44D3A	0	0	0	0	DOWN	53	3699DS-44E30	0	0	0	0	UP	54	3699DS-44D3A	0	0	0	0	DOWN	55	3699DS-44E30	0	0	0	0	UP	56	3699DS-44D3A	0	0	0	0	DOWN	57	3699DS-44E30	0	0	0	0	UP	58	3699DS-44D3A	0	0	0	0	DOWN	59	3699DS-44E30	0	0	0	0	UP	60	3699DS-44D3A	0	0	0	0	DOWN	61	3699DS-44E30	0	0	0	0	UP	62	3699DS-44D3A	0	0	0	0	DOWN	63	3699DS-44E30	0	0	0	0	UP	64	3699DS-44D3A	0	0	0	0	DOWN	65	3699DS-44E30	0	0	0	0	UP	66	3699DS-44D3A	0	0	0	0	DOWN	67	3699DS-44E30	0	0	0	0	UP	68	3699DS-44D3A	0	0	0	0	DOWN	69	3699DS-44E30	0	0	0	0	UP	70	3699DS-44D3A	0	0	0	0	DOWN	71	3699DS-44E30	0	0	0	0	UP	72	3699DS-44D3A	0	0	0	0	DOWN	73	3699DS-44E30	0	0	0	0	UP	74	3699DS-44D3A	0	0	0	0	DOWN	75	3699DS-44E30	0	0	0	0	UP	76	3699DS-44D3A	0	0	0	0	DOWN	77	3699DS-44E30	0	0	0	0	UP	78	3699DS-44D3A	0	0	0	0	DOWN	79	3699DS-44E30	0	0	0	0	UP	80	3699DS-44D3A	0	0	0	0	DOWN	81	3699DS-44E30	0	0	0	0	UP	82	3699DS-44D3A	0	0	0	0	DOWN	83	3699DS-44E30	0	0	0	0	UP	84	3699DS-44D3A	0	0	0	0	DOWN	85	3699DS-44E30	0	0	0	0	UP	86	3699DS-44D3A	0	0	0	0	DOWN	87	3699DS-44E30	0	0	0	0	UP	88	3699DS-44D3A	0	0	0	0	DOWN	89	3699DS-44E30	0	0	0	0	UP	90	3699DS-44D3A	0	0	0	0	DOWN	91	3699DS-44E30	0	0	0	0	UP	92	3699DS-44D3A	0	0	0	0	DOWN	93	3699DS-44E30	0	0	0	0	UP	94	3699DS-44D3A	0	0	0	0	DOWN	95	3699DS-44E30	0	0	0	0	UP	96	3699DS-44D3A	0	0	0	0	DOWN	97	3699DS-44E30	0	0	0	0	UP	98	3699DS-44D3A	0	0	0	0	DOWN	99	3699DS-44E30	0	0	0	0	UP	100	3699DS-44D3A	0	0	0	0	DOWN	<ul style="list-style-type: none"> • As you are starting at the end of the plate pack read the Plate Table from bottom and upwards
PLATE NO.			PLATE CODE	PUNCHED CORNER OF THE PLATE				FLOW DIRECTION ON THE GASKET SIDE OF THE PLATE																																																																																																																																																																																																																																																																																																																																																																																																																																																																																																																																																																																																																																																																																																																																
	UPPER LEFT	LOWER LEFT		UPPER RIGHT	LOWER RIGHT																																																																																																																																																																																																																																																																																																																																																																																																																																																																																																																																																																																																																																																																																																																																			
1	3699DS-44E30	0	0	0	0	UP																																																																																																																																																																																																																																																																																																																																																																																																																																																																																																																																																																																																																																																																																																																																		
2	3699DS-44D3A	0	0	0	0	DOWN																																																																																																																																																																																																																																																																																																																																																																																																																																																																																																																																																																																																																																																																																																																																		
3	3699DS-44E30	0	0	0	0	UP																																																																																																																																																																																																																																																																																																																																																																																																																																																																																																																																																																																																																																																																																																																																		
4	3699DS-44D3A	0	0	0	0	DOWN																																																																																																																																																																																																																																																																																																																																																																																																																																																																																																																																																																																																																																																																																																																																		
5	3699DS-44E30	0	0	0	0	UP																																																																																																																																																																																																																																																																																																																																																																																																																																																																																																																																																																																																																																																																																																																																		
6	3699DS-44D3A	0	0	0	0	DOWN																																																																																																																																																																																																																																																																																																																																																																																																																																																																																																																																																																																																																																																																																																																																		
7	3699DS-44E30	0	0	0	0	UP																																																																																																																																																																																																																																																																																																																																																																																																																																																																																																																																																																																																																																																																																																																																		
8	3699DS-44D3A	0	0	0	0	DOWN																																																																																																																																																																																																																																																																																																																																																																																																																																																																																																																																																																																																																																																																																																																																		
9	3699DS-44E30	0	0	0	0	UP																																																																																																																																																																																																																																																																																																																																																																																																																																																																																																																																																																																																																																																																																																																																		
10	3699DS-44D3A	0	0	0	0	DOWN																																																																																																																																																																																																																																																																																																																																																																																																																																																																																																																																																																																																																																																																																																																																		
11	3699DS-44E30	0	0	0	0	UP																																																																																																																																																																																																																																																																																																																																																																																																																																																																																																																																																																																																																																																																																																																																		
12	3699DS-44D3A	0	0	0	0	DOWN																																																																																																																																																																																																																																																																																																																																																																																																																																																																																																																																																																																																																																																																																																																																		
13	3699DS-44E30	0	0	0	0	UP																																																																																																																																																																																																																																																																																																																																																																																																																																																																																																																																																																																																																																																																																																																																		
14	3699DS-44D3A	0	0	0	0	DOWN																																																																																																																																																																																																																																																																																																																																																																																																																																																																																																																																																																																																																																																																																																																																		
15	3699DS-44E30	0	0	0	0	UP																																																																																																																																																																																																																																																																																																																																																																																																																																																																																																																																																																																																																																																																																																																																		
16	12...120 3699DS-44D3A	0	0	0	0	DOWN																																																																																																																																																																																																																																																																																																																																																																																																																																																																																																																																																																																																																																																																																																																																		
17	3699DS-44E30	0	0	0	0	UP																																																																																																																																																																																																																																																																																																																																																																																																																																																																																																																																																																																																																																																																																																																																		
18	3699DS-44D3A	0	0	0	0	DOWN																																																																																																																																																																																																																																																																																																																																																																																																																																																																																																																																																																																																																																																																																																																																		
19	3699DS-44E30	0	0	0	0	UP																																																																																																																																																																																																																																																																																																																																																																																																																																																																																																																																																																																																																																																																																																																																		
20	3699DS-44D3A	0	0	0	0	DOWN																																																																																																																																																																																																																																																																																																																																																																																																																																																																																																																																																																																																																																																																																																																																		
21	3699DS-44E30	0	0	0	0	UP																																																																																																																																																																																																																																																																																																																																																																																																																																																																																																																																																																																																																																																																																																																																		
22	3699DS-44D3A	0	0	0	0	DOWN																																																																																																																																																																																																																																																																																																																																																																																																																																																																																																																																																																																																																																																																																																																																		
23	3699DS-44E30	0	0	0	0	UP																																																																																																																																																																																																																																																																																																																																																																																																																																																																																																																																																																																																																																																																																																																																		
24	3699DS-44D3A	0	0	0	0	DOWN																																																																																																																																																																																																																																																																																																																																																																																																																																																																																																																																																																																																																																																																																																																																		
25	3699DS-44E30	0	0	0	0	UP																																																																																																																																																																																																																																																																																																																																																																																																																																																																																																																																																																																																																																																																																																																																		
26	3699DS-44D3A	0	0	0	0	DOWN																																																																																																																																																																																																																																																																																																																																																																																																																																																																																																																																																																																																																																																																																																																																		
27	3699DS-44E30	0	0	0	0	UP																																																																																																																																																																																																																																																																																																																																																																																																																																																																																																																																																																																																																																																																																																																																		
28	3699DS-44D3A	0	0	0	0	DOWN																																																																																																																																																																																																																																																																																																																																																																																																																																																																																																																																																																																																																																																																																																																																		
29	3699DS-44E30	0	0	0	0	UP																																																																																																																																																																																																																																																																																																																																																																																																																																																																																																																																																																																																																																																																																																																																		
30	3699DS-44D3A	0	0	0	0	DOWN																																																																																																																																																																																																																																																																																																																																																																																																																																																																																																																																																																																																																																																																																																																																		
31	3699DS-44E30	0	0	0	0	UP																																																																																																																																																																																																																																																																																																																																																																																																																																																																																																																																																																																																																																																																																																																																		
32	3699DS-44D3A	0	0	0	0	DOWN																																																																																																																																																																																																																																																																																																																																																																																																																																																																																																																																																																																																																																																																																																																																		
33	3699DS-44E30	0	0	0	0	UP																																																																																																																																																																																																																																																																																																																																																																																																																																																																																																																																																																																																																																																																																																																																		
34	3699DS-44D3A	0	0	0	0	DOWN																																																																																																																																																																																																																																																																																																																																																																																																																																																																																																																																																																																																																																																																																																																																		
35	3699DS-44E30	0	0	0	0	UP																																																																																																																																																																																																																																																																																																																																																																																																																																																																																																																																																																																																																																																																																																																																		
36	3699DS-44D3A	0	0	0	0	DOWN																																																																																																																																																																																																																																																																																																																																																																																																																																																																																																																																																																																																																																																																																																																																		
37	3699DS-44E30	0	0	0	0	UP																																																																																																																																																																																																																																																																																																																																																																																																																																																																																																																																																																																																																																																																																																																																		
38	3699DS-44D3A	0	0	0	0	DOWN																																																																																																																																																																																																																																																																																																																																																																																																																																																																																																																																																																																																																																																																																																																																		
39	3699DS-44E30	0	0	0	0	UP																																																																																																																																																																																																																																																																																																																																																																																																																																																																																																																																																																																																																																																																																																																																		
40	3699DS-44D3A	0	0	0	0	DOWN																																																																																																																																																																																																																																																																																																																																																																																																																																																																																																																																																																																																																																																																																																																																		
41	3699DS-44E30	0	0	0	0	UP																																																																																																																																																																																																																																																																																																																																																																																																																																																																																																																																																																																																																																																																																																																																		
42	3699DS-44D3A	0	0	0	0	DOWN																																																																																																																																																																																																																																																																																																																																																																																																																																																																																																																																																																																																																																																																																																																																		
43	3699DS-44E30	0	0	0	0	UP																																																																																																																																																																																																																																																																																																																																																																																																																																																																																																																																																																																																																																																																																																																																		
44	3699DS-44D3A	0	0	0	0	DOWN																																																																																																																																																																																																																																																																																																																																																																																																																																																																																																																																																																																																																																																																																																																																		
45	3699DS-44E30	0	0	0	0	UP																																																																																																																																																																																																																																																																																																																																																																																																																																																																																																																																																																																																																																																																																																																																		
46	3699DS-44D3A	0	0	0	0	DOWN																																																																																																																																																																																																																																																																																																																																																																																																																																																																																																																																																																																																																																																																																																																																		
47	3699DS-44E30	0	0	0	0	UP																																																																																																																																																																																																																																																																																																																																																																																																																																																																																																																																																																																																																																																																																																																																		
48	3699DS-44D3A	0	0	0	0	DOWN																																																																																																																																																																																																																																																																																																																																																																																																																																																																																																																																																																																																																																																																																																																																		
49	3699DS-44E30	0	0	0	0	UP																																																																																																																																																																																																																																																																																																																																																																																																																																																																																																																																																																																																																																																																																																																																		
50	3699DS-44D3A	0	0	0	0	DOWN																																																																																																																																																																																																																																																																																																																																																																																																																																																																																																																																																																																																																																																																																																																																		
51	3699DS-44E30	0	0	0	0	UP																																																																																																																																																																																																																																																																																																																																																																																																																																																																																																																																																																																																																																																																																																																																		
52	3699DS-44D3A	0	0	0	0	DOWN																																																																																																																																																																																																																																																																																																																																																																																																																																																																																																																																																																																																																																																																																																																																		
53	3699DS-44E30	0	0	0	0	UP																																																																																																																																																																																																																																																																																																																																																																																																																																																																																																																																																																																																																																																																																																																																		
54	3699DS-44D3A	0	0	0	0	DOWN																																																																																																																																																																																																																																																																																																																																																																																																																																																																																																																																																																																																																																																																																																																																		
55	3699DS-44E30	0	0	0	0	UP																																																																																																																																																																																																																																																																																																																																																																																																																																																																																																																																																																																																																																																																																																																																		
56	3699DS-44D3A	0	0	0	0	DOWN																																																																																																																																																																																																																																																																																																																																																																																																																																																																																																																																																																																																																																																																																																																																		
57	3699DS-44E30	0	0	0	0	UP																																																																																																																																																																																																																																																																																																																																																																																																																																																																																																																																																																																																																																																																																																																																		
58	3699DS-44D3A	0	0	0	0	DOWN																																																																																																																																																																																																																																																																																																																																																																																																																																																																																																																																																																																																																																																																																																																																		
59	3699DS-44E30	0	0	0	0	UP																																																																																																																																																																																																																																																																																																																																																																																																																																																																																																																																																																																																																																																																																																																																		
60	3699DS-44D3A	0	0	0	0	DOWN																																																																																																																																																																																																																																																																																																																																																																																																																																																																																																																																																																																																																																																																																																																																		
61	3699DS-44E30	0	0	0	0	UP																																																																																																																																																																																																																																																																																																																																																																																																																																																																																																																																																																																																																																																																																																																																		
62	3699DS-44D3A	0	0	0	0	DOWN																																																																																																																																																																																																																																																																																																																																																																																																																																																																																																																																																																																																																																																																																																																																		
63	3699DS-44E30	0	0	0	0	UP																																																																																																																																																																																																																																																																																																																																																																																																																																																																																																																																																																																																																																																																																																																																		
64	3699DS-44D3A	0	0	0	0	DOWN																																																																																																																																																																																																																																																																																																																																																																																																																																																																																																																																																																																																																																																																																																																																		
65	3699DS-44E30	0	0	0	0	UP																																																																																																																																																																																																																																																																																																																																																																																																																																																																																																																																																																																																																																																																																																																																		
66	3699DS-44D3A	0	0	0	0	DOWN																																																																																																																																																																																																																																																																																																																																																																																																																																																																																																																																																																																																																																																																																																																																		
67	3699DS-44E30	0	0	0	0	UP																																																																																																																																																																																																																																																																																																																																																																																																																																																																																																																																																																																																																																																																																																																																		
68	3699DS-44D3A	0	0	0	0	DOWN																																																																																																																																																																																																																																																																																																																																																																																																																																																																																																																																																																																																																																																																																																																																		
69	3699DS-44E30	0	0	0	0	UP																																																																																																																																																																																																																																																																																																																																																																																																																																																																																																																																																																																																																																																																																																																																		
70	3699DS-44D3A	0	0	0	0	DOWN																																																																																																																																																																																																																																																																																																																																																																																																																																																																																																																																																																																																																																																																																																																																		
71	3699DS-44E30	0	0	0	0	UP																																																																																																																																																																																																																																																																																																																																																																																																																																																																																																																																																																																																																																																																																																																																		
72	3699DS-44D3A	0	0	0	0	DOWN																																																																																																																																																																																																																																																																																																																																																																																																																																																																																																																																																																																																																																																																																																																																		
73	3699DS-44E30	0	0	0	0	UP																																																																																																																																																																																																																																																																																																																																																																																																																																																																																																																																																																																																																																																																																																																																		
74	3699DS-44D3A	0	0	0	0	DOWN																																																																																																																																																																																																																																																																																																																																																																																																																																																																																																																																																																																																																																																																																																																																		
75	3699DS-44E30	0	0	0	0	UP																																																																																																																																																																																																																																																																																																																																																																																																																																																																																																																																																																																																																																																																																																																																		
76	3699DS-44D3A	0	0	0	0	DOWN																																																																																																																																																																																																																																																																																																																																																																																																																																																																																																																																																																																																																																																																																																																																		
77	3699DS-44E30	0	0	0	0	UP																																																																																																																																																																																																																																																																																																																																																																																																																																																																																																																																																																																																																																																																																																																																		
78	3699DS-44D3A	0	0	0	0	DOWN																																																																																																																																																																																																																																																																																																																																																																																																																																																																																																																																																																																																																																																																																																																																		
79	3699DS-44E30	0	0	0	0	UP																																																																																																																																																																																																																																																																																																																																																																																																																																																																																																																																																																																																																																																																																																																																		
80	3699DS-44D3A	0	0	0	0	DOWN																																																																																																																																																																																																																																																																																																																																																																																																																																																																																																																																																																																																																																																																																																																																		
81	3699DS-44E30	0	0	0	0	UP																																																																																																																																																																																																																																																																																																																																																																																																																																																																																																																																																																																																																																																																																																																																		
82	3699DS-44D3A	0	0	0	0	DOWN																																																																																																																																																																																																																																																																																																																																																																																																																																																																																																																																																																																																																																																																																																																																		
83	3699DS-44E30	0	0	0	0	UP																																																																																																																																																																																																																																																																																																																																																																																																																																																																																																																																																																																																																																																																																																																																		
84	3699DS-44D3A	0	0	0	0	DOWN																																																																																																																																																																																																																																																																																																																																																																																																																																																																																																																																																																																																																																																																																																																																		
85	3699DS-44E30	0	0	0	0	UP																																																																																																																																																																																																																																																																																																																																																																																																																																																																																																																																																																																																																																																																																																																																		
86	3699DS-44D3A	0	0	0	0	DOWN																																																																																																																																																																																																																																																																																																																																																																																																																																																																																																																																																																																																																																																																																																																																		
87	3699DS-44E30	0	0	0	0	UP																																																																																																																																																																																																																																																																																																																																																																																																																																																																																																																																																																																																																																																																																																																																		
88	3699DS-44D3A	0	0	0	0	DOWN																																																																																																																																																																																																																																																																																																																																																																																																																																																																																																																																																																																																																																																																																																																																		
89	3699DS-44E30	0	0	0	0	UP																																																																																																																																																																																																																																																																																																																																																																																																																																																																																																																																																																																																																																																																																																																																		
90	3699DS-44D3A	0	0	0	0	DOWN																																																																																																																																																																																																																																																																																																																																																																																																																																																																																																																																																																																																																																																																																																																																		
91	3699DS-44E30	0	0	0	0	UP																																																																																																																																																																																																																																																																																																																																																																																																																																																																																																																																																																																																																																																																																																																																		
92	3699DS-44D3A	0	0	0	0	DOWN																																																																																																																																																																																																																																																																																																																																																																																																																																																																																																																																																																																																																																																																																																																																		
93	3699DS-44E30	0	0	0	0	UP																																																																																																																																																																																																																																																																																																																																																																																																																																																																																																																																																																																																																																																																																																																																		
94	3699DS-44D3A	0	0	0	0	DOWN																																																																																																																																																																																																																																																																																																																																																																																																																																																																																																																																																																																																																																																																																																																																		
95	3699DS-44E30	0	0	0	0	UP																																																																																																																																																																																																																																																																																																																																																																																																																																																																																																																																																																																																																																																																																																																																		
96	3699DS-44D3A	0	0	0	0	DOWN																																																																																																																																																																																																																																																																																																																																																																																																																																																																																																																																																																																																																																																																																																																																		
97	3699DS-44E30	0	0	0	0	UP																																																																																																																																																																																																																																																																																																																																																																																																																																																																																																																																																																																																																																																																																																																																		
98	3699DS-44D3A	0	0	0	0	DOWN																																																																																																																																																																																																																																																																																																																																																																																																																																																																																																																																																																																																																																																																																																																																		
99	3699DS-44E30	0	0	0	0	UP																																																																																																																																																																																																																																																																																																																																																																																																																																																																																																																																																																																																																																																																																																																																		
100	3699DS-44D3A	0	0	0	0	DOWN																																																																																																																																																																																																																																																																																																																																																																																																																																																																																																																																																																																																																																																																																																																																		

CLEANING PLATES

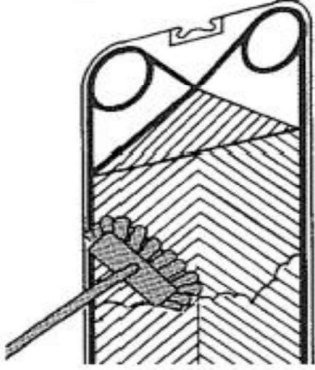
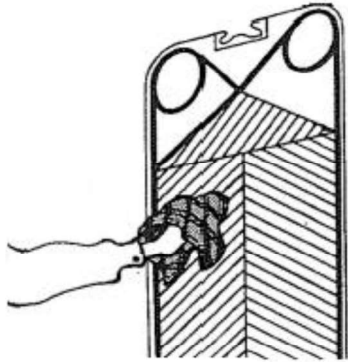
	<ul style="list-style-type: none"> • Remove Hydrocarbon-based deposits with a • Paraffinic or Naptha based solvent
	<ul style="list-style-type: none"> • Dry with a cloth or rinse with water

NOTE ! Natural, butyl and EPDM rubber gaskets swell in these media. Limit contact to 1/2 hour.

NOTE! THE FOLLOWING SOLVENTS SHOULD NOT BE USED:

- Ketones (e.g. Acetone, Methylketone, Hethylisobutylketone)
- Esters (e.g. Ethylacetate, Butylacetate)
- Halogenated hydrocarbons (e.g. Chlorothene, Carbon tetrachloride, Freons)
- Aromatics (e.g. Benzene, Toluene)

REGASKETING

Glued Gaskets

- A special glue is recommended for Viton and silicone gaskets.
- A two-component, cold curing epoxy glue gives a strong joint for higher temperatures. Future removal of gaskets usually requires heating or freezing of the joint.
- A single-component rubber-based solvent adhesive is normally used for repair work in an uncured condition. It can be used for operating temperatures below 95° C. For operating temperatures above 95° C and oil coolers/heaters, the glued joints should be cured at 120° C for one hour. Gasket removal can usually be carried out without heating of the cement joints.

Clip-on Gaskets

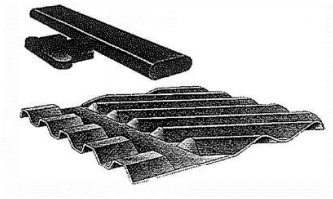

Clip on gasket

- The Clip-on gasket is attached to the plate by two gasket prongs which slip under the edge of the plate to hold the gasket securely in alignment in the gasket groove. The prongs are situated at regular intervals around the periphery of the plate.
- When the plate heat exchanger is assembled and tightened, the gasket provides a tight seal around the plate.

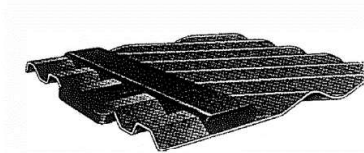

The Clip-on gasket in the gasket groove.

NOTE: before closing the apparatus: Check that the two gasket prongs are in the correct position.

TROUBLE SHOOTING

1. LEAKING BETWEEN PLATE PACK & FRAME

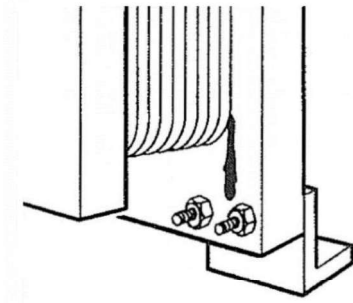

Action

- Mark the area of the leakage and open the heat exchanger.
- Inspect the condition of gasket of the end plate and the connection.
- Look for dislocation, foreign objects, scars and other damage to the gasket surfaces.

Correction

- Remove the gasket; remove foreign matter; replace any damaged gasket; replace connection lining if applicable.

Action

- Check the surface of the pressure plate for unevenness, foreign objects etc., that might interfere with the joint between the gasket and the adjacent surface.

Correction

- Clean gasket and pressure plate surface.

Action

- Check the plate for cracks and holes.

Correction

- A perforated or damaged end plate must be replaced

2. LEAKING BETWEEN PLATES

NOTE: On a Plate Heat Exchanger, especially one designed for high temperature duties, extreme and sudden temperature drops may sometimes cause temporary leakage. The heat exchanger will normally seal again when the temperatures have stabilized.

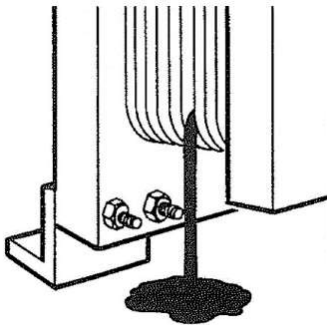

Action

- Mark the two plates either side of the leak.
- Check and note the length of the plate pack between inside frame plate and inside pressure plate
- Open the heat exchanger

Checking Gaskets

Action

- Inspect the gasket condition and check for a loose, dislocated or damaged gasket
- Re-position gasket;
- Re-cement loose gasket; or
- Replace damaged gasket.
- Check the surface of the pressure plate damage for unevenness and remove foreign objects etc.
- Check plate pack length against drawing to see if plate or gasket damage has been caused by over-tightening of the plate pack or the leak is simply caused by insufficient tightening. Insufficient tightening must be corrected.

Correction

- A damaged plate must be taken out for repair or replacement.
- If it is a regular plate with 4 holes, take the damaged plate plus either the 4-hole plate immediately in front or immediately behind it out of the plate pack.
- The heat exchanger can now be reassembled and put back in service **ENSURE THE PLATE PACK IS TIGHTENED TO THE NEW MEASUREMENT WHICH IS EQUAL TO THE ONE ON THE DRAWING REDUCED BY TWO TIMES THE SPACE REQUIRED PER PLATE.**
- The small reduction of the heat transfer area is normally of no importance for a short period of time.

Checking Plates

Action

- Check hanger recess at both plate ends for deformations which may cause misalignment between the plates.

Correction

- Damaged hanger recesses must be repaired if possible or the plate replaced. For temporary arrangement with reduced number of plates (see above).

Action

- Make sure that the plates are hanging correctly as A-B-A (see above)

Correction

- Incorrect sequence of plates must be corrected (A-B-A-B-..).

Action

- Check for perforation of the plate (corrosion).

Correction

- Perforated plates must be replaced. For temporary solution see above.

MAKE SURE THAT NO PLATE HAS BEEN DAMAGED BEFORE REASSEMBLING THE PLATE PACK!

3. INCREASED PRESSURE DROP

Action:

- Check all valves are open including non-return valves.
- Measure the pressure drop and the flow rate just before and just after the heat exchanger.
- For viscous media a membrane manometer with a diameter of at least 30 mm should be used.
- Measure or estimate the flow rate if possible.
- Compare the pressure drop observed with that specified. (See data print out).
- If pressure is higher than specified the temperature program should also be checked:
- If the thermometer readings correspond to the specifications, the heat transfer surface is probably clean enough, but the inlet to the heat exchanger may be blocked.
- If the thermometer readings do NOT correspond to the specifications the heat transfer is probably dropping below specification due to deposits on the heat transfer surface. This may also increase the pressure drop.

Correction:

- Open the heat exchanger and back-flush system to remove any obstruction
- If a 'cleaning-in-place' (CIP) system is available, wash out the deposits.
- If CIP is not available, open the heat exchanger and clean the plates.
- If the pressure drop is corresponding to the specifications, there is no need for any action.
- If the pressure drop is lower than specified, the pump capacity is too small or the observation is wrong. Refer to the pump manual.

4. MIXING OF MEDIA

Action

- Check that the piping is connected to the heat exchanger at the correct locations.

Correction

- Relocate piping to correct connections.

Action

- Open the lower connection on one side and raise pressure on the other side.
- By looking into the open connection try to detect any liquid from the pressurized side leaking in and ascertain approximately how far into the plate pack the leakage is located.
- If no leakage is detected then look elsewhere for the cause of the mixing of media.
- If a leak is detected mark the position of the leak along the plate pack and then open the heat exchanger.
- First check that the corner areas between the ring and the field gaskets are clear and the leakage slots are open to ensure no pressure can build up and force the media across the gasket sealing off the other liquid and any leakage is to atmosphere.

Correction

- Remove all deposits or material that can block the free exit from the area. If the leak channels of the gasket have been blocked, reopen them with a suitable tool or replace the gasket.
- If a leak has not been located check each single plate for possible perforations using any of the following methods:
 - Put a strong light behind the plate and watch for light coming through fine holes or cracks;
 - Use a magnifying glass to check the suspect area; or
 - Use a chemical penetrant after having cleaned the plates well.

Correction

- Plates with holes should be replaced. For a temporary solution with reduced number of plates, see above: ‘Leakage between plates’.

5. FALLING HEAT TRANSFER CAPACITY

Action

- Measure temperatures and flow rates at inlets and outlets on both media sides if possible;
- Both temperatures and the flow rate must be measured on at least one of the media;
- Check to see if the transferred amount of heat energy corresponds to the specifications;
- If precision is important it will be necessary to use laboratory thermometers.

Correction

- If the heat transfer capacity of the apparatus has dropped below specified values, the heat transfer surface must be cleaned.
- Either use CIP equipment or open the heat exchanger for visual inspection and manual cleaning.